

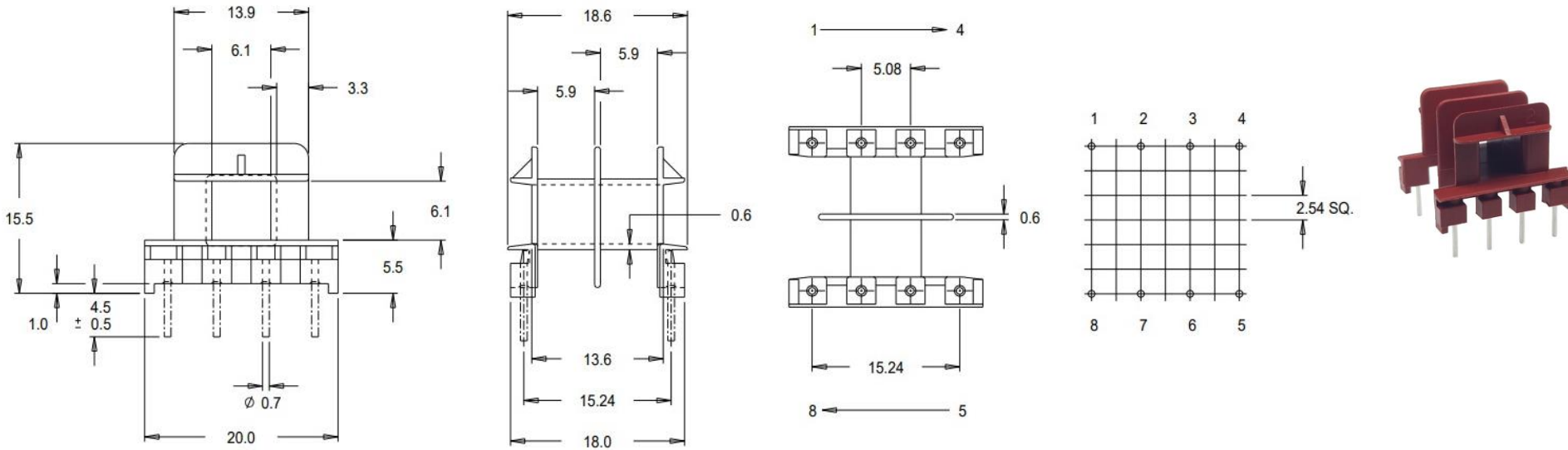

FE0071



Part Number FE0071	Part Weight (g) 2.5	Carton Quantity 4000	Pinning Configuration TPB-RD-070 1:2:3:4:5:6:7:8:
Order Code FE0071FGNNAT0001	Material Nylon PA66	Carton Size (mm) 465x315x260	Pin Length (mm) (from standoff) 4.5
Part Description Bobbin E20/10/6 H 8P 2S UL94V0	Material Datasheets	Related Items EF20CLIPM-00	Terminal Pin Material Phosphor Bronze
Product Range E/EF Range	UL Rating UL94V0	3D CAD Image	Compliance information

MILES - PLATTS

+44 (0)116 264 3850

milesplatts.co.uk

enquiries@milesplatts.co.uk